

Miño

TRITURADORA MIÑO

CARACTERÍSTICAS	T-MÑ-5-1000	T-MÑ-5-1200	T-MÑ-5-1400	T-MÑ-5-1600	T-MÑ-5-1800	T-MÑ-5-2000	T-MÑ-5-2200
Ancho Trabajo Working width / Largeur de travail Arbeitsbreite	1000	1200	1400	1600	1800	2000	2200
Ancho total Total width / Largeur totale Gesamtbreite	1220	1420	1620	1820	2020	2220	2420
Peso Kg. Weight kg / Poids (kg) Gewicht Kg.	485	555	485	555	625	695	765
Martillos Hammers / Marteaux Hammer	10	10	12	16	16	20	20
Correas V-belts / Courroies Gürtel	3	3	3	3	3	3	4
HP (indicativo) HP (indicative) / Ch (indicatif) PS (Richtwert)	30-50	30-50	40-60	50-70	60-80	70-90	80-100
R.P.M. R.P.M. / Tr/min U/min	540	540	540	540	540	540	540
EJE SHAFT / AXE ACHSE	1 3/8 Z-6	1 3/8 Z-6	1 3/8 Z-6	1 3/8 Z-6	1 3/8 Z-6	1 3/8 Z-6	1 3/8 Z-6



TRITURADORAS PICURSA, S.L.
Ctra. Gallur-Sangüesa, km. 16,700
50660 Tauste (Zaragoza) España
Tel.: +34 976 85 43 28
trituradoras@picursa.com

DELEGACIÓN SUR PICURSA
Polígono Cornicabral, Nave 11
23280 Beas de Segura (Jaén)



[youtube.com/TrituradorasPicursa](https://www.youtube.com/TrituradorasPicursa)

Distribuidor / Reseller / Revendeur / Verteiler



Miño



AGRICULTURAL MULCHERS
BROYEUR AGRICOLE
LANDWIRTSCHAFTLICHE MULCHER

TRITURADORAS AGRICOLAS

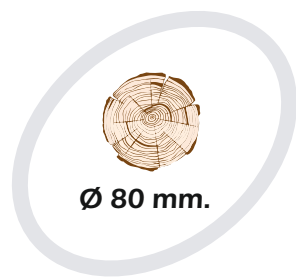

Ø 80 mm.

- ROTOR MARTILLO OSCILANTE CON DISTRIBUCIÓN ESPECIAL, BAJA ABSORCIÓN DE POTENCIA
- SWINGING HAMMER ROTOR WITH SPECIAL DISTRIBUTION, LOW POWER ABSORPTION
- ROTOR MARTEAUX OSCILLANTS AVEC DISTRIBUTION SPÉCIALE, FAIBLE ABSORPTION DE PUISSANCE
- OSZILLIERENDER HAMMERROTOR MIT SPEZIELLER VERTEILUNG, NIEDRIGER ENERGIEVERBRAUCH

- DOBLE CHASIS
- TWIN CHASSIS
- DOUBLE CHÂSSIS
- DOPPELRAHMEN

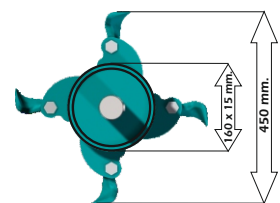

- DIAMETRO EJE Ø 50 mm.
- AXLE DIAMETER Ø 50 mm.
- DIAMÈTRE DE L'AXE Ø 50 mm.
- ACHSDURCHMESSER Ø 50 mm.



- TIPO MARTILLO
- HAMMER TYPES
- TYPE DE MARTEAU
- HAMMERTYP

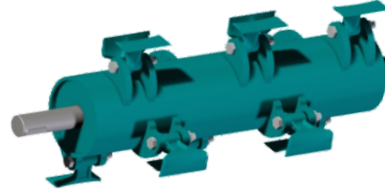

- CARCASAS DE RODAMIENTOS EN HIERRO FUNDIDO
- CAST IRON BEARING SHELLS
- STRUCTURES DE ROULEMENT EN FONTE
- LAGERGEHÄUSE AUS GUSSEISEN

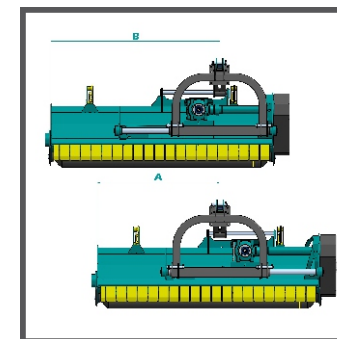
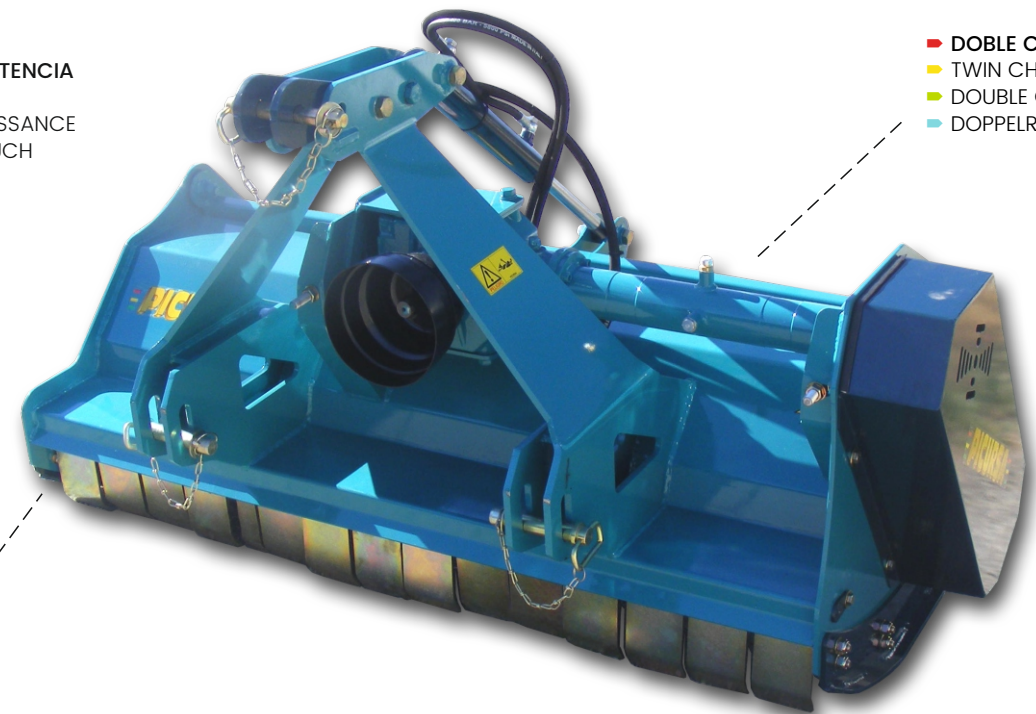

Ancho Trabajo Working width / Largeur de travail Arbeitsbreite	A mm.	B mm.
1400	530	930
1600	700	1130
1800	830	1330
2000	1030	1530
2200	1230	1730

ACCESORIOS OPCIONALES ■ OPTIONAL ACCESSORIES ■ ACCESSOIRES OPTIONNELS ■ OPTIONALES ZUBEHÖR



- RULO TRASERO
- REAR ROLLER
- ROULEAU ARRIÈRE
- WALZE HINTEN



- RASCADOR DEL RULO TRASERO
- REAR ROLLER SCRAPER
- RACLETTE DU ROULEAU ARRIÈRE
- ABSTREIFER FÜR HINTERE WALZE

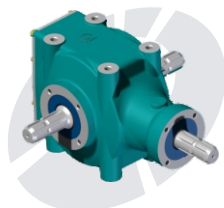

- PLUS GRUPO CON RUEDA LIBRE
- PLUS GROUP WITH FREE WHEEL
- PLUS GROUPE AVEC ROUE LIBRE
- PLUS FREIE RADGRUPPE

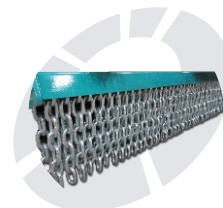

- JUEGO DE CADENAS DELANTERAS
- FRONT CHAIN SET
- ENSEMBLE CHAÎNES AVANT
- KETTENSATZ VORNE



- PLUS TRANSMISIÓN CON RUEDA LIBRE
- FREE WHEEL TRANSMISSION
- TRANSMISSION À ROUE LIBRE
- GETRIEBE MIT FREIEM RAD

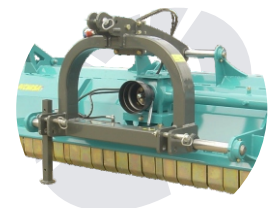

- DESPLAZAMIENTO HIDRÁULICO
- HYDRAULIC MOVEMENT
- DÉPLACEMENT HYDRAULIQUE
- HYDRAULISCHE BEFÖRDERUNG

ES

La trituradora de tractor modelo Miño esta especialmente diseñada para la trituración de todo tipo de cultivos, hierba, matorrales bajos y ramas de hasta 8 cm. de diámetro. Su compuerta trasera hidráulica aporta gran cantidad de posibilidades. Baja absorción de potencia. Construcción muy sólida y robusta. Triturado uniforme.

- DOBLE CHÁSIS
- CORREAS CON FIBRA DE KEVLAR.
- MARTILLOS BAJA ABSORCIÓN DE POTENCIA
- TORNILLOS DE LOS MARTILLOS EN ACERO 12.9
- TRANSMISIÓN INCLUIDA.

EN

The Miño mulcher for tractor is specially designed to shred all types of crops, grass, low scrub and branches of up to 8cm in diameter. Its hydraulic rear hood offers a large range of possibilities. Low power absorption. Very solid and sturdily built. Uniform shredding.

- TWIN CHASSIS
- V-BELTS WITH KEVLAR FIBRES
- HAMMERS WITH LOW POWER ABSORPTION
- HAMMER SCREWS MADE OF 12.9 STEEL
- TRANSMISSION INCLUDED

FR

Le broyeur pour tracteur modèle Miño est spécialement conçu pour le broyage de tous types de cultures, d'herbes, de fourrés bas et de branches allant jusqu'à 8 cm de diamètre. Sa porte arrière hydraulique offre de nombreuses possibilités. Faible absorption de puissance. Construction très robuste et durable. Broyage uniforme.

- DOBLE CHÂSSIS
- COURROIES EN FIBRE DE KEVLAR
- MARTEAUX FAIBLE ABSORPTION DE PUISSANCE
- VIS DES MARTEAUX EN ACIER 12.9
- TRANSMISSION INCLUSE

DE

Der landwirtschaftliche Mulcher, Modell Miño, dient speziell der Zerkleinerung aller Arten von Pflanzen, Gras, niedrigem Gestrüpp und Ästen bis 8 cm Durchmesser. Die Hydraulikklappe hinten bietet zahlreiche Möglichkeiten. Niedrige Leistungsaufnahme. Sehr stabile und widerstandsfähige Bauweise. Gleichförmige Zerkleinerung.

- DOPPELRAHMEN
- KEILRIEMEN AUS KEVLAR-FASER
- HÄMMER MIT NIEDRIGER LEISTUNGS-AUFNAHME
- HAMMERSCHRAUBEN AUS STAHL 12.9
- EINSCHLIESSLICH GETRIEBE